

EXTRALIGHT

tavoli riunione / meeting table / tables de réunion

2019 / design R&S PROF



IT— Semplice e versatile, Extralight è una collezione di scrivanie e tavoli riunione caratterizzata da un'essenziale struttura metallica e da un piano leggero, che si inserisce facilmente in ambienti di lavoro diversi. Ricca è la proposta di materiali e finiture, con tonalità coordinate su tutte le superfici.

EN— Simple and versatile, Extralight is a collection of desks and meeting tables characterized by an essential metal structure and a light top, which fits easily into different work environments. Rich is the proposal of materials and finishes, with coordinated shades on all surfaces.

F— Simple et polyvalent, Extralight est une collection de bureaux et de tables de réunion caractérisée par une structure métallique essentielle et un plateau léger, qui s'intègre facilement dans différents environnements de travail. Rich est la proposition des matériaux et des finitions assortis de nuances coordonnées sur toutes les surfaces.

**PR
OF**

TAVOLO RIUNIONE
MEETING TABLE
TABLE DE RÉUNION

IT— Il tavolo riunione è previsto in profondità 1000/1230 mm ed ha una struttura composta da due gambe a portale realizzate in tubolari di acciaio 70x70 mm nelle finiture metallo opaco. I piani possono essere in legno impiallacciato, Fenix NTM®, melaminico con pannelli spessore di 18/19 mm o in vetro spessore totale 18 mm con lastre di 4 mm su supporto melaminico bianco o nero sp. 14 mm con bordo in tinta con il piano.

EN— The meeting table is available in depths 1000/1230 mm and has a structure composed of two portal legs made of 70x70 mm steel tubes in matt metal finishes. The tops can be in wood veneer, Fenix NTM®, melamine with 18/19 mm thick panels or in glass with a total thickness of 18 mm with 4 mm slabs glued on a white or black melamine top 14 mm th. with edge matching the top.

F— La table de réunion est disponible en profondeurs: 1000/1230 mm et a une structure composée de deux pieds de portail en tubes d'acier de 70x70 mm avec des finitions en métal mat. Les plateaux peuvent être en bois plaqué, Fenix NTM®, en mélamine avec des panneaux d'une épaisseur de 18/19 mm ou en verre d'une épaisseur totale de 18 mm avec des feuilles de 4 mm collé sur un plateau mélaminé blanc ou noir ép. 14 mm avec le bord correspondant au plateau.

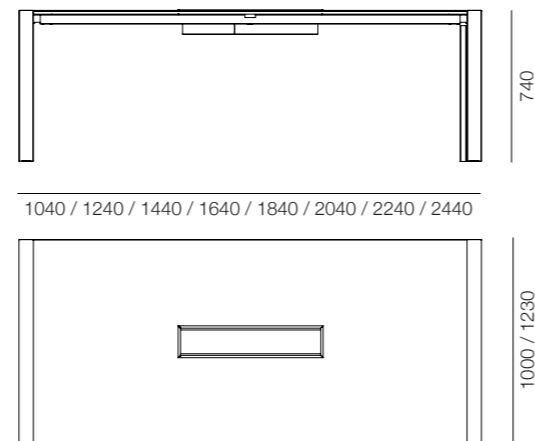

TAVOLO RIUNIONE MODULARE
MODULAR MEETING TABLE
TABLE DE RÉUNION MODULAIRE

IT— Il tavolo riunione modulare è composto da piani componibili in profondità 1230 mm con gamba centrale condivisa per la canalizzazione verticale.

EN— The modular meeting table is composed of modular tops in depth 1230 mm with a central shared leg for vertical channeling.

F— La table de réunion modulaire est composée de plans de travail modulables à profondeur de 1230 mm avec un pied central partagé pour une canalisation verticale.

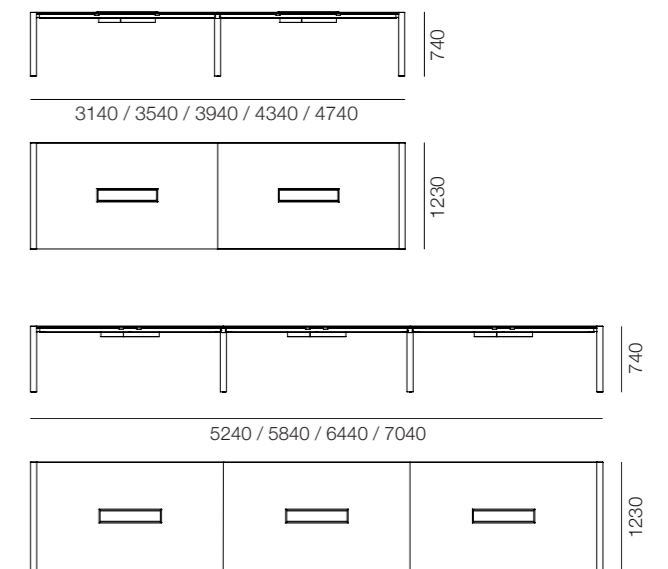
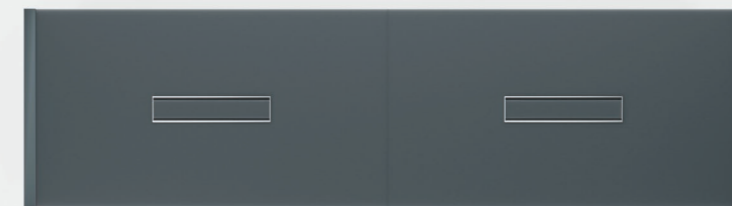



TAVOLO RIUNIONE
MEETING TABLE
TABLE DE RÉUNION

IT— Il tavolo riunione è previsto in profondità 1630 mm ed ha una struttura composta da due gambe a portale realizzate in tubolari di acciaio 70x70 mm nelle finiture metallo opaco. I piani possono essere in legno impiallacciato, Fenix NTM®, melaminico con pannelli spessore di 18/19 mm o in vetro spessore totale 18 mm con lastre di 4 mm su supporto melaminico bianco o nero sp. 14 mm con bordo in tinta con il piano.

EN— The meeting table is available in depth 1630 mm and has a structure composed of two portal legs made of 70x70 mm steel tubes in matt metal finishes. The tops can be in wood veneer, Fenix NTM®, melamine with 18/19 mm thick panels or in glass with a total thickness of 18 mm with 4 mm slabs glued on a white or black melamine top 14 mm th. with edge matching the top.

F— La table de réunion est disponible en profondeur 1630 mm et a une structure composée de deux pieds de portail en tubes d'acier de 70x70 mm avec des finitions en métal mat. Les plateaux peuvent être en bois plaqué, Fenix NTM®, en mélamine avec des panneaux d'une épaisseur de 18/19 mm ou en verre d'une épaisseur totale de 18 mm avec des feuilles de 4 mm collé sur un plateau mélaminé blanc ou noir ép. 14 mm avec le bord correspondant au plateau.

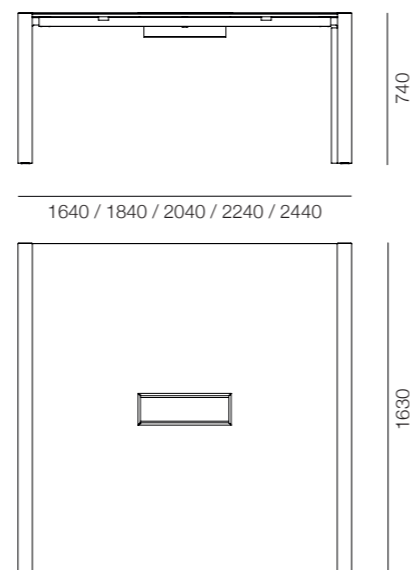

TAVOLO RIUNIONE MODULARE
MODULAR MEETING TABLE
TABLE DE RÉUNION MODULAIRE

IT— Il tavolo riunione modulare è composto da piani componibili in profondità 1630 mm con gamba centrale condivisa per la canalizzazione verticale.

EN— The modular meeting table is composed of modular tops in depth 1630 mm with a central shared leg for vertical channeling.

F— La table de réunion modulaire est composée de plans de travail modulables à profondeur de 1630 mm avec un pied central partagé pour une canalisation verticale.

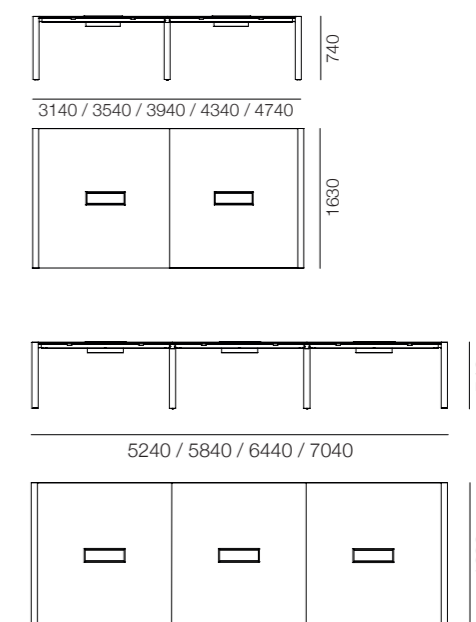



PASSAGGIO CAVI TAVOLO RIUNIONE
CABLE MANAGEMENT MEETING TABLE
PASSAGE DES CÂBLES TABLE DE RÉUNION

IT— Il tavolo riunione può essere dotato di un piccolo carter in tinta fissato ad una gamba con magneti per agevolare e nascondere il passaggio verticale dei cavi e una vasca per la canalizzazione orizzontale. Il piano può avere un passacavo metallico rettangolare Proficable in diverse lunghezze in finitura anodizzata alluminio, nero, ottone o verniciato bianco con sportello apribile in tinta con il piano.
 Il tavolo riunione modulare ha una gamba centrale per la canalizzazione verticale.

EN— The meeting table can be equipped with a small colored carter fixed to one leg with magnets to facilitate and hide the vertical passage of the cables and a carter for horizontal cabling. The top can have a rectangular metal cable tidy in different lengths in anodized aluminum, black, brass or white painted finish with an openable door in the same color as the top.
 The modular meeting table has a central leg for vertical ducting.



F— La table de réunion peut être équipée d'un petit carter coloré fixé à une jambe avec des aimants pour faciliter et masquer le passage vertical des câbles et d'un réservoir pour un cablage horizontal. Le dessus peut comporter un passe cable rectangulaire en métal de différentes longueurs, en aluminium anodisé, peint en noir, en laiton ou en blanc, avec un top pouvant être ouverte de la même couleur que le dessus.
 La table de réunion modulaire a un pied central pour le cablage vertical.

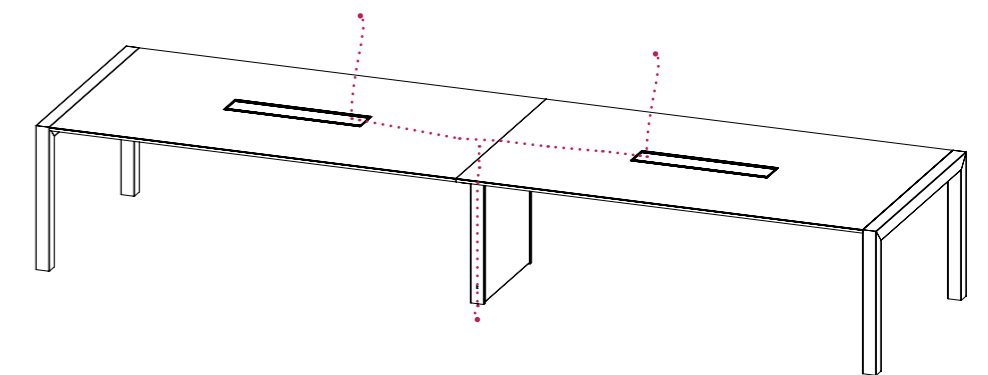

FINITURE - FINISHES - FINITIONS

PIANO - TOP - PLATEAU

ME - Melaminico - Melamine - Mélamine



MC - Colore melaminico - Melamine color - Couleur mélaminé

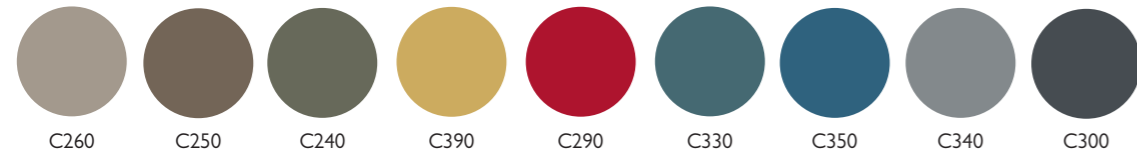

LA - Laccato opaco plus - Matt lacquered plus - Laqué mat plus

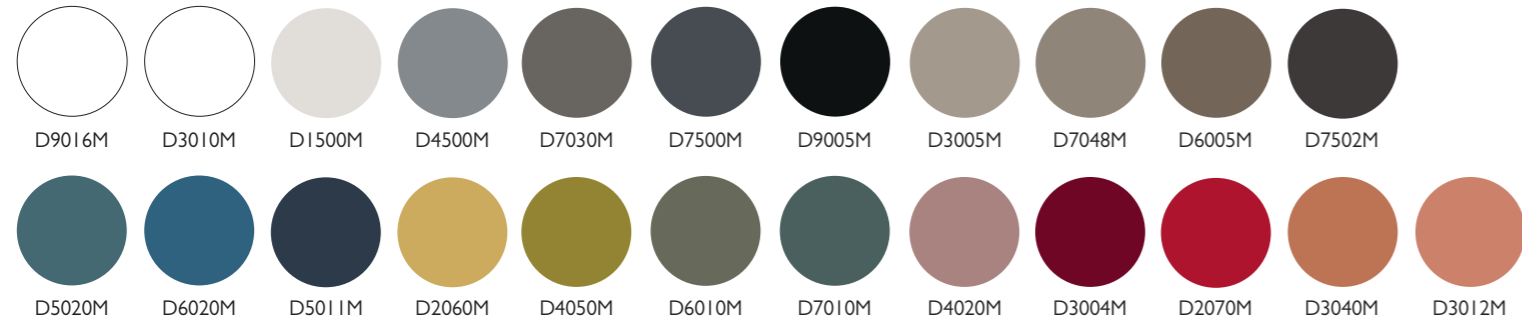

FX - Fenix NTM



IM - Impiallacciato legno - Wood veneer - Plaqué bois



FINITURE - FINISHES - FINITIONS

SB - Vetro stampato brillante - Brilliant printed glass - Verre imprimé brillant

SA - Vetro stampato anti touch - Anti touch printed glass - Verre imprimé anti empreintes

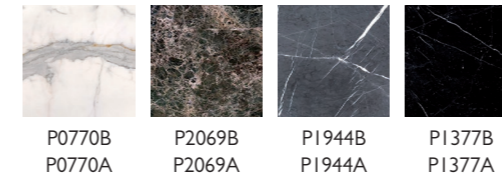

VB - Vetro laccato brillante - Brilliant lacquered glass - Verre laqué brillant

VA - Vetro laccato anti touch - Anti touch lacquered glass - Verre laqué anti empreintes

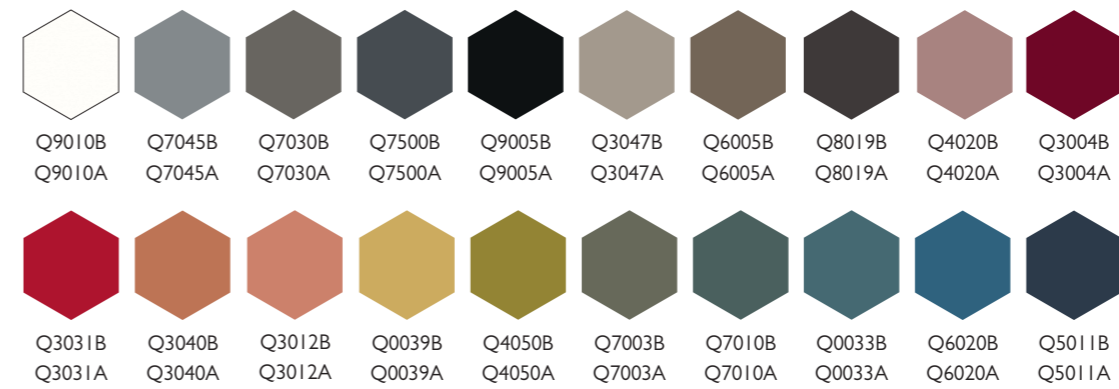

FINITURE - FINISHES - FINITIONS

GAMBE - LEGS - PIEDS

MO - Metallo verniciato opaco - Matt varnished metal - Métal verni mat



E90100 E70470 E70450 E7030M E7500M E50110 E90050 E10360



E3047M E70480 E70030 E80190 E0033M E30040 E30310 E30120

LA - Laccato opaco plus - Matt lacquered plus - Laqué mat plus



D9016M D3010M D1500M D4500M D7030M D7500M D9005M D3005M D7048M D6005M D7502M



D5020M D6020M D5011M D2060M D4050M D6010M D7010M D4020M D3004M D2070M D3040M D3012M

FINITURE - FINISHES - FINITIONS

PASSACAVO - CABLE TIDY - PASSE CÂBLE

MO - Metallo verniciato opaco - Matt varnished metal - Métal verni mat

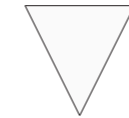

E90100

OS - Alluminio ossidato - oxidized aluminum - Aluminium oxydé



OB7S OASC OE8S