



**IT**— Semplice e versatile, Extralight è una collezione di scrivanie e tavoli riunione caratterizzata da un'essenziale struttura metallica e da un piano leggero, che si inserisce facilmente in ambienti di lavoro diversi. Ricca è la proposta di materiali e finiture, con tonalità coordinate su tutte le superfici.

**EN**— Simple and versatile, Extralight is a collection of desks and meeting tables characterized by an essential metal structure and a light top, which fits easily into different work environments. Rich is the proposal of materials and finishes, with coordinated shades on all surfaces.

**F**— Simple et polyvalent, Extralight est une collection de bureaux et de tables de réunion caractérisée par une structure métallique essentielle et un plateau léger, qui s'intègre facilement dans différents environnements de travail. Rich est la proposition des matériaux et des finitions assortis de nuances coordonnées sur toutes les surfaces.

SCRIVANIA  
DESK  
BUREAU

**IT**— La scrivania ha una struttura composta da due gambe a portale realizzate in tubolari di acciaio 70x70 mm nelle finiture metallo opaco. I piani possono essere in legno impiallacciato, Fenix NTM®, melaminico con pannelli spessore di 18/19 mm o in vetro spessore totale 18 mm con lastre di 4 mm su supporto melaminico bianco o nero sp. 14 mm con bordo in tinta con il piano. Su richiesta è disponibile la gonna di altezza 360 mm nelle stesse finiture del piano.

**EN**— The desk has a structure composed of two portal legs made of 70x70 mm steel tubes in matt metal finishes. The tops can be in wood veneer, Fenix NTM®, melamine with 18/19 mm thick panels or in glass with a total thickness of 18 mm with 4 mm slabs glued on a white or black melamine top 14 mm th. with edge matching the top. On request the 360 mm high modesty panel is available in the same finishes as the top.

**F**— Le bureau a une structure composée de deux pieds de portail en tubes d'acier de 70 x 70 mm aux finitions en métal mat. Les plateaux peuvent être en bois plaqué, Fenix NTM®, en mélamine avec des panneaux d'une épaisseur de 18/19 mm ou en verre d'une épaisseur totale de 18 mm avec des feuilles de 4 mm collé sur un plateau mélaminé blanc ou noir ép. 14 mm avec le bord correspondant au plateau. Sur demande la voile de fond haute de 360 mm est disponible dans les mêmes finitions que le plateau.

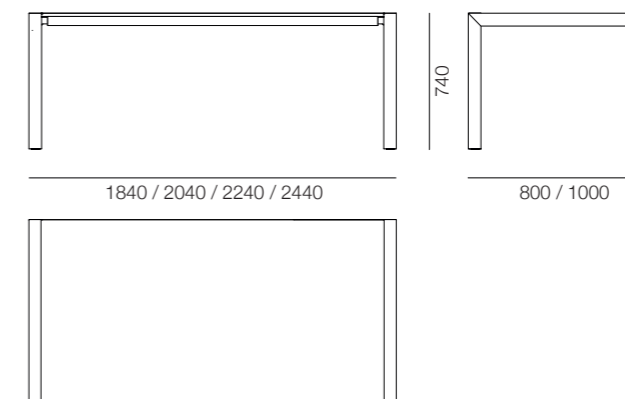
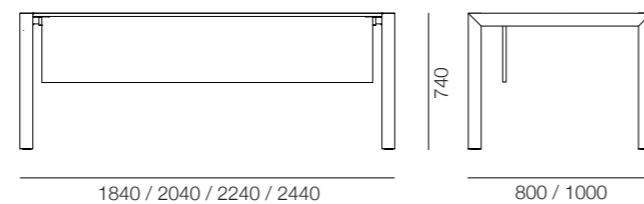

SCRIVANIA + DATTILO  
DESK + EXTENSION  
BUREAU + EXTENSION

**IT**— La scrivania ha una struttura composta da tre gambe a portale realizzate in tubolari di acciaio 70x70 mm nelle finiture metallo opaco, di cui una speciale dedicata per supportare il piano dattilo. I piani possono essere in legno impiallacciato, Fenix NTM®, melaminico con pannelli spessore di 18/19 mm o in vetro spessore totale 18 mm con lastre di 4 mm su supporto melaminico bianco o nero sp. 14 mm con bordo in tinta con il piano. Su richiesta è disponibile la gonna di altezza 360 mm nelle stesse finiture del piano.

**EN**— The desk has a structure composed of three portal legs made of 70x70 mm steel tubes in matt metal finishes, one of which is dedicated to supporting the extension table top. The tops can be in wood veneer, Fenix NTM®, melamine with 18/19 mm thick panels or in glass with a total thickness of 18 mm with 4 mm slabs glued on a white or black melamine top 14 mm th. with edge matching the top. On request the 360 mm high modesty panel is available in the same finishes as the top.

**F**— Le bureau a une structure composée de trois pieds à portail en tubes d'acier de 70 x 70 mm aux finitions en métal mat, dont l'un est dédié au support du plateau de table. Les plateaux peuvent être en bois plaqué, Fenix NTM®, en mélamine avec des panneaux d'une épaisseur de 18/19 mm ou en verre d'une épaisseur totale de 18 mm avec des feuilles de 4 mm collé sur un plateau mélaminé blanc ou noir ép. 14 mm avec le bord correspondant au plateau. Sur demande la voile de fond haute de 360 mm est disponible dans les mêmes finitions que le plateau.

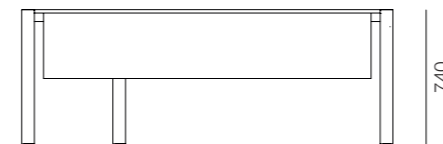

1840 / 2040 / 2240 / 2440

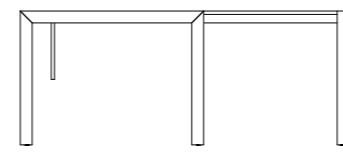

1600 / 2000

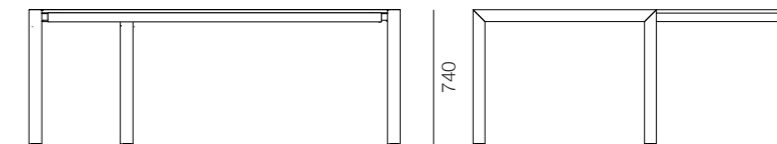

1840 / 2040 / 2240 / 2440

1600 / 2000

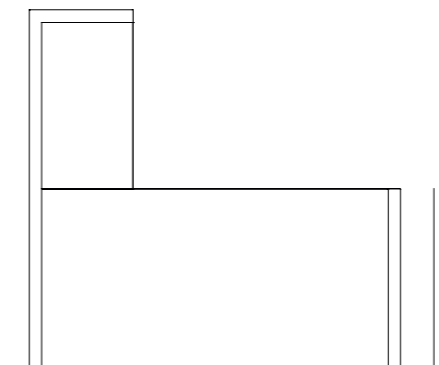

800 / 1000



SCRIVANIA + MODULAR UNIT  
DESK + MODULAR UNIT  
BUREAU + MODULAR UNIT

**IT**— La scrivania ha una struttura composta da due gambe a portale realizzate in tubolari di acciaio 70x70 mm nelle finiture metallo opaco, di cui una speciale in appoggio su modular unit. I piani possono essere in legno impiallacciato, Fenix NTM®, melaminico con pannelli spessore di 18/19 mm o in vetro spessore totale 18 mm con lastre di 4 mm su supporto melaminico bianco o nero sp. 14 mm con bordo in tinta con il piano. Su richiesta è disponibile la gonna di altezza 360 mm nelle stesse finiture del piano. Il modular unit è un mobile contenitore composto da elementi modulari liberamente accostabili tra loro in profondità 600 mm e in due larghezze 416 mm e 832 mm. Si può scegliere il modulo a giorno, porta cpu, chiuso con anta, a 1 cassetto e classificatore, a 3 cassetti, con maniglia o push to open. È disponibile anche il modulo con vani a giorno di testa iniziale o finale.

**EN**— The desk has a structure composed of two portal legs made of 70x70 mm steel tubes in matt metal finishes, of which a special one rests on a modular unit. The tops can be in veneered wood, Fenix NTM®, melamine with 18/19 mm thick panels or in glass with a total thickness of 18 mm with 4 mm slabs glued on a white or black melamine top 14 mm th. with edge matching the top. On request the 360 mm high modesty panel is available in the same finishes as the top. The modular unit is a storage unit composed of modular elements freely accessible together at a depth of 600 mm and in two widths 416 mm and 832 mm. You can choose the open module, cpu holder, closed with door, 1 drawer and filing cabinet, 3 drawers, with handle or push to open. The module with the open compartments at the beginning and at the end is also available.

**F**— Le bureau a une structure composée de deux pieds à portail en tubes d'acier de 70x70 mm en finitions métal mat, dont l'un spécial repose sur un modular unit. Les plateaux peuvent être en bois plaqué, Fenix NTM®, en mélamine avec des panneaux de 18/19 mm d'épaisseur ou en verre de 18 mm d'épaisseur avec des plaques de 4 mm collé sur un plateau mélaminé blanc ou noir ép. 14 mm avec le bord correspondant au plateau. Sur demande la voile de fond haute de 360 mm est disponible dans les mêmes finitions que le plateau. Le modular unit est une unité de stockage composée d'éléments modulaires librement accessibles entre eux à une profondeur de 600 mm et en deux largeurs de 416 mm et 832 mm. Vous pouvez choisir le module ouvert, le support du processeur, fermé avec porte, 1 tiroir et classeur, 3 tiroirs, avec poignée ou bouton poussoir pour ouvrir. Le module avec des espaces ouverts initial ou final est également disponible.

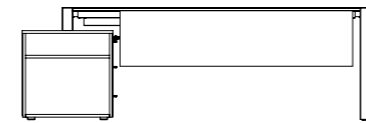

2105 / 2305 / 2505 / 2705

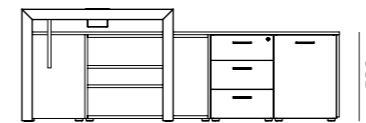

2100

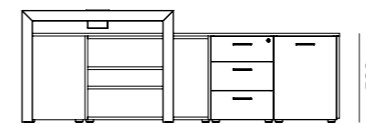

2100

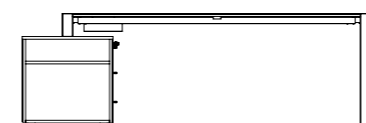
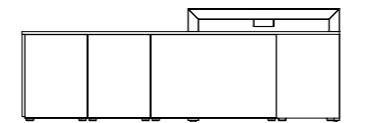

740

2105 / 2305 / 2505 / 2705

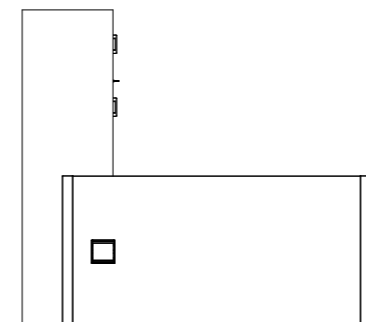



PASSAGGIO CAVI SCRIVANIA  
DESK CABLE MANAGEMENT  
PASSAGE DES CÂBLES BUREAU

**IT**— La scrivania può essere dotata di un piccolo carter in tinta fissato ad una gamba tramite dei magneti per agevolare e nascondere il passaggio verticale dei cavi e una vasca per la canalizzazione orizzontale. Il piano può avere un passacavo Profcable rettangolare o quadrato in finitura anodizzata alluminio, nero, ottone o verniciato bianco con sportello apribile in tinta con il piano. È prevista anche la possibilità di installare un caricatore wireless a scomparsa totale nel piano. Il modular unit è attrezzabile su richiesta con il medesimo passacavo.

**EN**— The desk can be equipped with a small colored carter fixed to one leg by magnets to facilitate and hide the vertical passage of the cables and a carter for horizontal cabling. The top can have a rectangular or square Profcable in anodized aluminum, black, brass or white painted finish with an openable door in the same color as the top. There is also the possibility of installing a fully concealed wireless charger in the plan. The modular unit can be equipped on request with the same cable tidy.

**F**— Le bureau peut être équipé d'un petit carter coloré fixé à une jambe par des aimants pour faciliter et masquer le passage vertical des câbles et d'un réservoir pour canalisation horizontale. Le plateau peut comporter un passe-câble Profcable rectangulaire ou carré en aluminium anodisé, peint en noir, en laiton ou en blanc avec une porte ouvrable de la même couleur que le plateau. Il est également possible d'installer un chargeur sans fil entièrement dissimulé dans le plan. Le modular unit peut être équipée sur demande du même passe-câble.

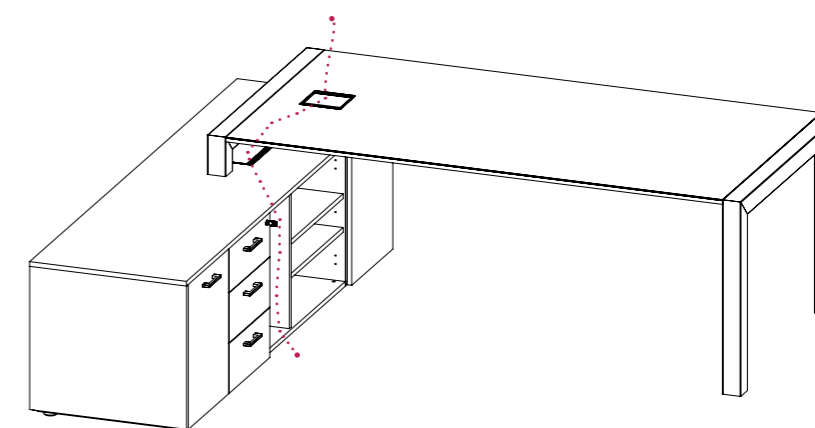
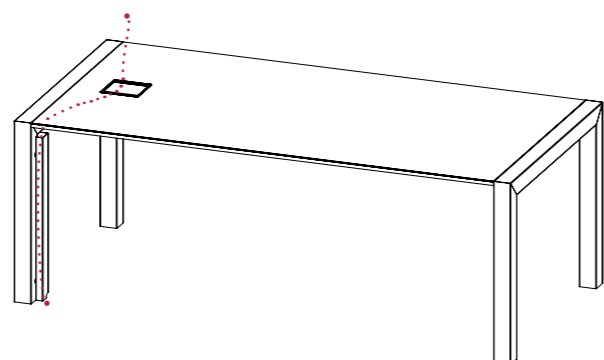
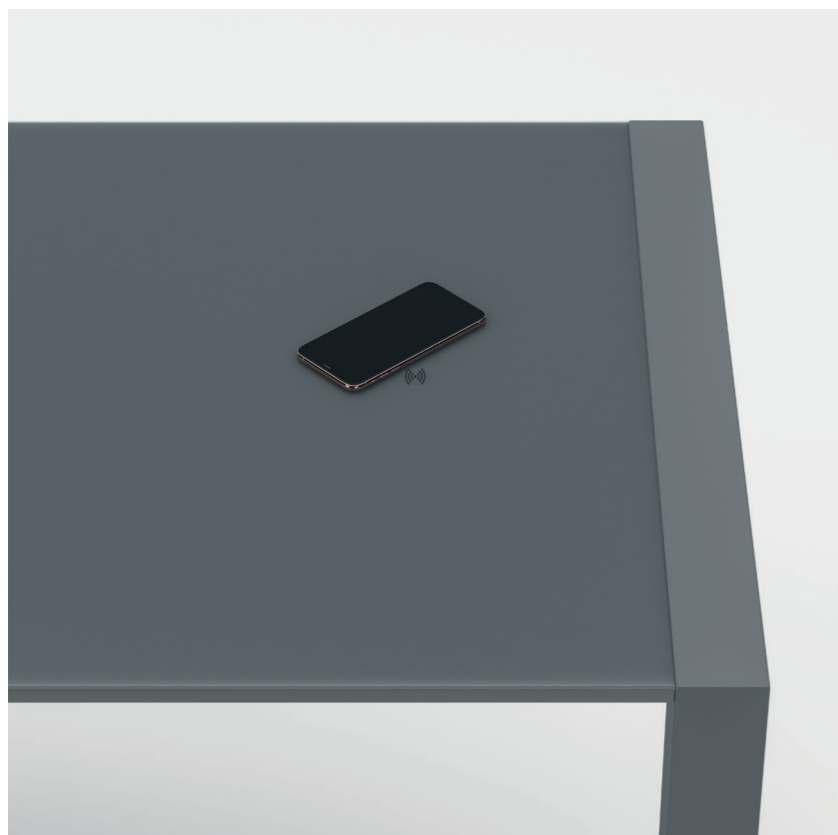

FINITURE - FINISHES - FINITIONS

PIANO - TOP - PLATEAU

ME - Melaminico - Melamine - Mélamine



MC - Colore melaminico - Melamine color - Couleur mélaminé

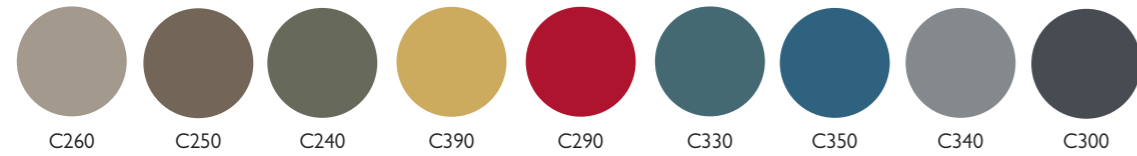

LA - Laccato opaco plus - Matt lacquered plus - Laqué mat plus

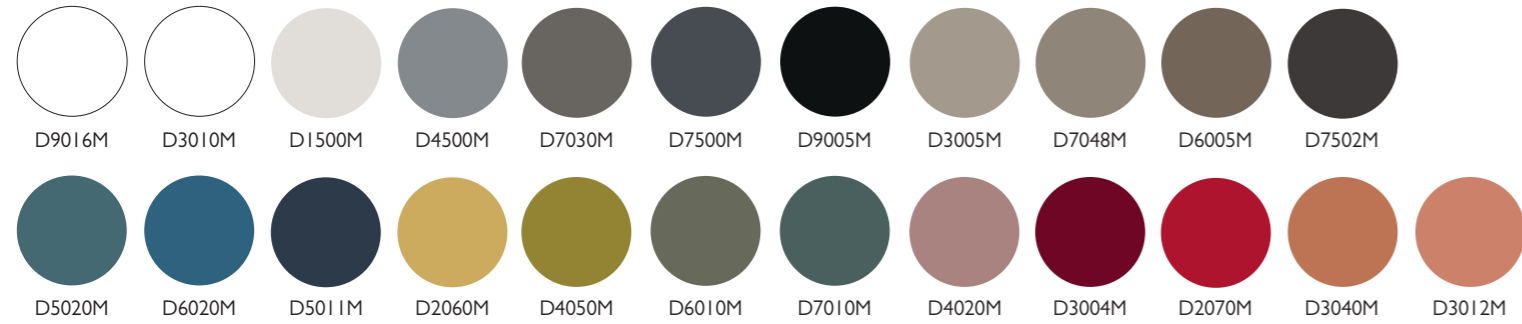

FX - Fenix NTM

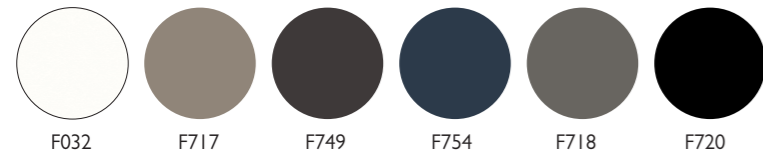

IM - Impiallacciato legno - Wood veneer - Plaqué bois



FINITURE - FINISHES - FINITIONS

SB - Vetro stampato brillante - Brilliant printed glass - Verre imprimé brillant

SA - Vetro stampato anti touch - Anti touch printed glass - Verre imprimé anti empreintes

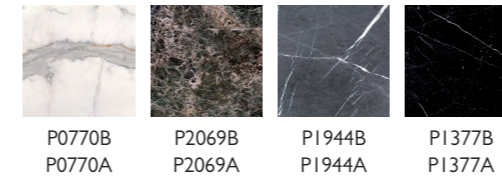

VB - Vetro laccato brillante - Brilliant lacquered glass - Verre laqué brillant

VA - Vetro laccato anti touch - Anti touch lacquered glass - Verre laqué anti empreintes

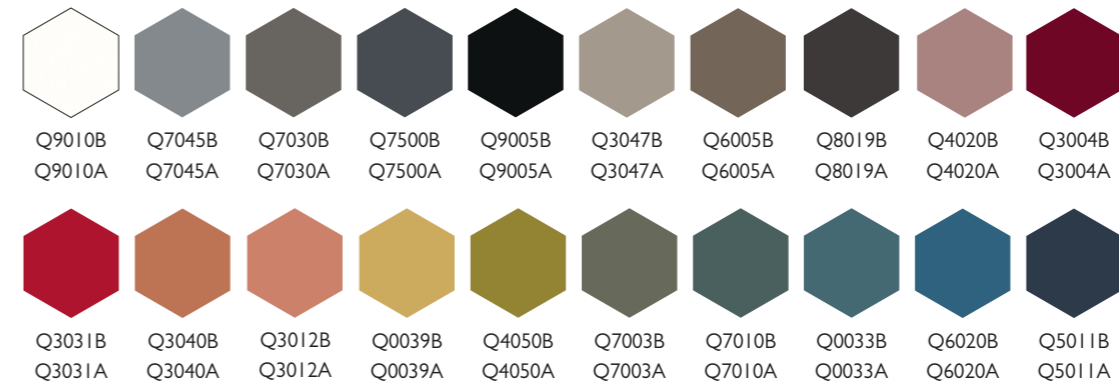

FINITURE - FINISHES - FINITIONS

GAMBE - LEGS - PIEDS

---

**MO - Metallo verniciato opaco - Matt varnished metal - Métal verni mat**



E90100 E70470 E70450 E7030M E7500M E50110 E90050 E10360



E3047M E70480 E70030 E80190 E0033M E30040 E30310 E30120

**LA - Laccato opaco plus - Matt lacquered plus - Laqué mat plus**



D9016M D3010M D1500M D4500M D7030M D7500M D9005M D3005M D7048M D6005M D7502M



D5020M D6020M D5011M D2060M D4050M D6010M D7010M D4020M D3004M D2070M D3040M D3012M

FINITURE - FINISHES - FINITIONS

PASSACAVO - CABLE TIDY - PASSE CÂBLE

---

**MO - Metallo verniciato opaco - Matt varnished metal - Métal verni mat**

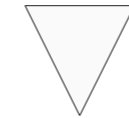

E90100

**OS - Alluminio ossidato - oxidized aluminum - Aluminium oxydé**



OB7S OASC OE8S